

HERE COMES THE SUN • CFO interview • **SHAREHOLDER VOICES**  
The age of new materials • **THE FUTURE OF WINDMILLS** • Tunneling  
**HALFTIME FOR THE VASA PROJECT** • 20 years of Meet Sandvik

# MEET #2 - 2016 SANDVIK

SANDVIK GROUP MAGAZINE

## EVOLVING SOCIETIES IN A CHANGING WORLD

Sandvik stands at the forefront  
of an exciting transition with  
urbanization at its center. **PAGE 10**

**HERE COMES THE SUN**  
**U.S.** Seventeen solar farms have been financed in the U.S. in the past couple of years. **PAGE 4**

**CAPTURING THE POWER OF THE WIND**  
**EUROPE** The search for smart ways to harness the power of the wind has triggered a wave of innovative solutions. **PAGE 20**

**SERVICE AGREEMENT**  
**CHINA** Two-year agreement signed with China Molybdenum. **PAGE 6**

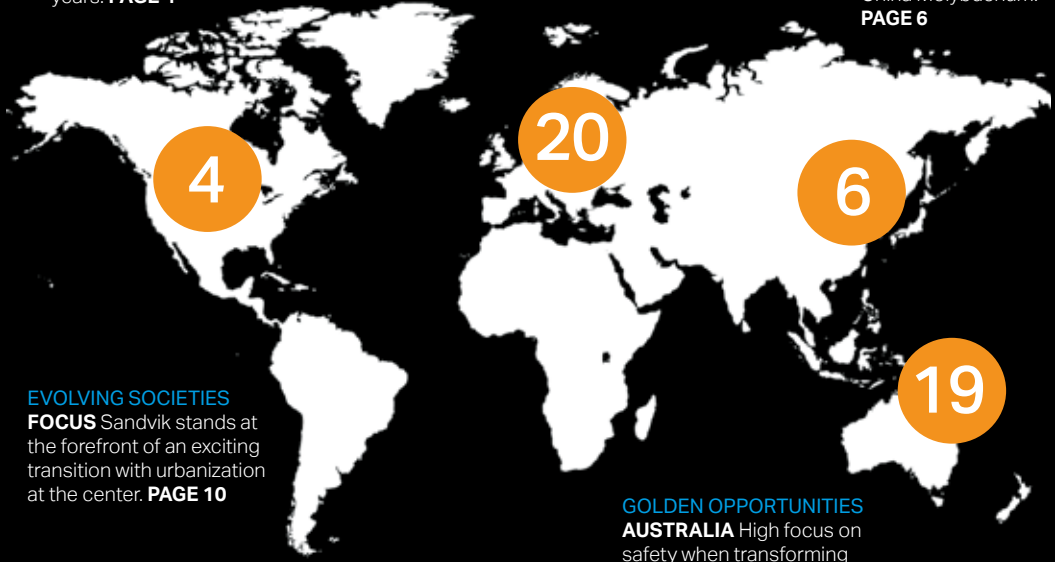

**EVOLVING SOCIETIES**  
**FOCUS** Sandvik stands at the forefront of an exciting transition with urbanization at the center. **PAGE 10**

**GOLDEN OPPORTUNITIES**  
**AUSTRALIA** High focus on safety when transforming an open-pit mine to an underground mine. **PAGE 19**

# CONTENT #2-2016



Follow us in social media and find more stories at: [home.sandvik.com/sandvikstories](http://home.sandvik.com/sandvikstories)



**MEET SANDVIK:** The Sandvik Group magazine

**PUBLISHER RESPONSIBLE UNDER SWEDISH PRESS LAW:** Pär Altan

**EDITOR-IN-CHIEF:** Sophie Öberg **PRODUCTION:** Spoon Publishing AB

**PRINT:** Falk Graphic **DATE OF PRINT:** May 2016

Published in Swedish and English, in printed form and at our website [home.sandvik.com](http://home.sandvik.com)

**EMAIL:** [info.group@sandvik.com](mailto:info.group@sandvik.com) . Copyright © 2016 Sandvik Group – All rights reserved.

All Sandvik trademarks mentioned in the magazine are owned by the Sandvik Group.



## DEAR READER,

**SANDVIK OPERATES IN** a global arena in which many factors influence our performance. We pay close attention to the changes that are taking place around us at all times, in particular the global trends that can impact on our business. But we are also involved in shaping this new world, adapting and constantly improving our offerings to our customers.

This issue features concrete examples on how we are contributing to the development of the societies in which we live. These include a focus on higher productivity and energy efficiency, improved resource utilization and enhanced safety. Gotthard Base Tunnel in Switzerland, the world's longest and deepest tunnel, Highway 91, which runs through southern California, and the new high-speed train in Norway are three instances of where we have contributed to extensive infrastructure projects.

**IN TODAY'S WORLD**, adaptability is the name of the game, on both a large and small scale. As communicated during the Annual General Meeting in Sandviken, Sweden, on April 28, we are driving Sandvik forward to be even more decentralized, more efficient and more customer-focused. The changes that we recently announced for Sandvik Mining, Sandvik Construction and Sandvik Venture exemplify the new Sandvik. We will focus on our core business in order to achieve stable and profitable growth.

**THE ANNUAL GENERAL MEETING** gave me a wonderful opportunity to meet many of you whom I have not met before or don't see on a regular basis. I was particularly impressed by the commitment and knowledge of our shareholders: Read what shareholders Erika Backman and Curt Bergström have to say on page 29. To have employees and shareholders with such loyalty and long-term ambition is a true strength factor. These qualities, combined with enhanced adaptability, are a good starting point as we work to drive Sandvik forward.

*Meet Sandvik* is a fine example of our ongoing development and adaptability. For two decades, it has been adapting to meet and reflect readers' needs and requests. On page 30–31, we look back on those years.

Please let us know what you would like *Meet Sandvik* to include in the future. I would be very grateful if you can take the time to complete our questionnaire. You will find the link on page 31.

Enjoy reading!

Björn Rosengren, President and CEO





# HERE COMES THE SUN

In 2009 there were no solar farms larger than 100 megawatts in the United States, but in the past couple of years 17 projects of that size have been financed. In sunny California, the state's three major utilities will be able to meet or exceed a 33 percent renewable energy mandate by 2020.

Solar panels consist of paper-thin silicon wafers with a layer of chemicals on top that can turn sunshine into electricity. Sandvik produces diffusion cassettes that are used in the production of the crystalline silicon wafers. The advanced powder metallurgical wire in the cassettes exceeds all other types in terms of process reliability, energy savings and lifespan, thanks to its unique properties, which include exceptional form stability and oxidation resistance. ■

# NEWS



## OWN TOP-LEVEL DOMAIN

As one of the first companies in the world, Sandvik has launched its own top-level domain, [home.sandvik.com](http://home.sandvik.com).

# >1,000

**Sandvik has developed a breakthrough production method for weld-free coiled tubing in lengths exceeding 1,000 meters from a single 125 kg hollow, with zero welds.**

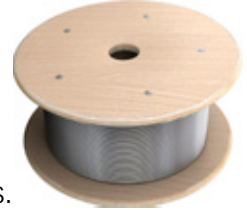

## SANDVIK 365 IMPROVES PRODUCTIVITY

**SANDVIK HAS SIGNED** a two-year Protective Services agreement with the Chinese company China Molybdenum, whose main activity is the mining and processing of molybdenum, tungsten, gold and other precious metals. A plant audit revealed issues with the cone crusher CH895, and new recommendations were made. As a result, the crushing chamber service life is already showing an increase of 50 percent due to the tramp metal detection process and improved maintenance procedures, and the site has achieved a 15 percent production volume increase.

Sandvik 365 is an umbrella concept for Sandvik Mining's aftermarket solutions. Read more at [mining.sandvik.com/sandvik365](http://mining.sandvik.com/sandvik365).



Derya Yasar, Accountant,  
Sandvik Turkey.

## SANDVIK CELEBRATES 50 YEARS IN TURKEY

Sandvik started its operations in Turkey in 1966, in a small apartment office in Istanbul with just a few employees. In the intervening years the Turkish organization has grown to some 150 employees working in six different offices in Istanbul, Ankara and Bursa. The majority of Sandvik's sales in Turkey comes from tools, tooling systems, mining and construction industries.

"To celebrate the 50 years the company has been operational in Turkey, Sandvik Turkey has launched a "1,000 plants for 50 years" campaign in which 1,000 tree seedlings have been planted in İzmir to create a celebration forest," comments Ilknur Anadol, Managing Director at Sandvik Turkey.



# NEW JUMBO TAKES TUNNELING TO A NEW LEVEL

**SANDVIK'S NEW TUNNELING JUMBO** makes excavation easier than ever with improved automation technology and intelligent features.

DT922i has been designed to maximize precision and performance while automating as much of the drilling and planning process as possible. Equipped with the powerful rock drill RD525, the jumbo's intelligent control system lets the operator choose between several different modes to take drilling accuracy to a whole new level. It also comes with an ergonomic cabin that provides 25 percent greater visibility and guarantees reduced noise levels of less than 69 dB at all times.

DT922i is capable of excavating cross sections up to 125 square meters. Furthermore, it includes the iSURE® tunnel management tool for creating accurate plans for drilling, charging and blasting as well as data collection and analysis functions.

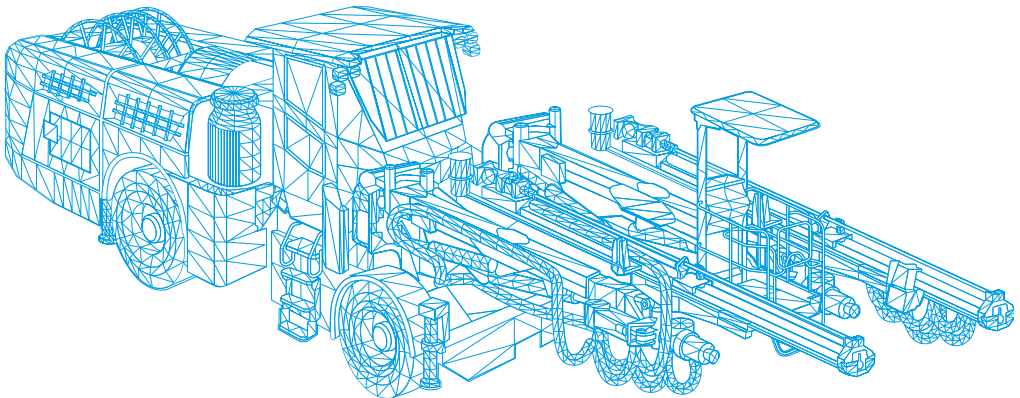

## **FOCUS ON ENVIRONMENT**

DT922i uses only LED lights, which consume less energy and have a longer lifetime than traditional lights. It also comes equipped with a fuel-efficient diesel engine.

## **DRILLING CAPABILITY**

RD525 rock drill provides a penetration rate that is 17 percent higher than its predecessors, while the shank life has been extended by 40 percent.



## THE RACE IS ON – FOR STRONGER, LIGHTER AND MORE SUSTAINABLE MATERIALS

“Materials have always been about enthusiasm. Materials are a dream that we have realized. Everything is possible, it’s just that we have to make it happen,” says Mark Miodownik, author behind the popular book *Stuff Matters*, in the fourth film of the *Looking Ahead* series.

**THROUGHOUT HISTORY**, materials and advances in material technology have influenced humankind. Now we just might be on the verge of the next shift in this type of technology, enabling products and functions we never believed possible.

Demands from industry are requiring that materials be lighter, tougher, thinner, denser and more flexible or rigid, as well as being heat- and wear-resistant.

Researchers are pushing the boundaries of what we imagine is possible, seeking to improve and enhance existing materials and at the same time come up with completely new materials that, while years away from day-to-day use, take us down entirely new technological pathways.

Which material will dominate our time? In Sandvik Coromant’s new film *Looking Ahead 4: Tomorrow’s Materials*, we explore graphene as well as composites and their properties.

**WATCH THE FILM:** [www.sandvik.coromant.com/lookingahead](http://www.sandvik.coromant.com/lookingahead)



## NEW OBJECTIVES AND TARGETS

### WITHIN ENVIRONMENT, HEALTH AND SAFETY (EHS)

Sandvik has launched new EHS objectives and targets for 2016–2020, and a new Environmental and Climate Change strategy. Read more at our website, [home.sandvik/sustainablebusiness](http://home.sandvik/sustainablebusiness).

## OPENING TIME FOR THE WORLD'S LONGEST AND DEEPEST TRAFFIC TUNNEL

The world's longest and deepest traffic tunnel, Gotthard Base Tunnel in Switzerland, will be officially opened in June. Sandvik drills, loaders and breakers have been used in the most demanding section of the tunnel, the Sedrun passage. The poor stability of the rock, along with a construction point that was being supplied through an

800-meter-deep shaft, made the work very challenging.

"All our machines had to be dismantled for the shaft. The challenging conditions required innovative thinking and close co-operation with both the customer and our distributor," says Pekka Nieminen, Vice President, Business development PA Equipment Sandvik Construction.



Axera T12-Sedrun in action in the tunnel.

## DIGITAL NEWS



### THE CRUSHOLOGY WEB PORTAL

aims to help quarry owners and operators to get more out of their equipment. The portal features a collection of practical tips, downloadable guides, articles, films and much more. Read more at [crushology.sandvik.com](http://crushology.sandvik.com).

**THE SANDVIK WELDING APP** is developed for welding professionals and combines the full contents of *Sandvik Welding Handbook* with useful calculators for all types of welding challenges. Available in app stores.



**SANDVIK MATERIALS ACADEMY** is an external training program, including classroom training as well as e-learning. It is a new part of Sandvik's offerings aimed at increasing the knowledge and understanding of stainless steel, material properties and applications. Read more at [smt.sandvik.com/academy](http://smt.sandvik.com/academy).

**THE SANDVIK 365 IPAD APP** is a collection of hard facts and concrete data about Sandvik Mining's after-market solutions designed to keep customers productive every day of the year. Available in app stores.

# FOCUS

A nighttime photograph of a city skyline, likely Shanghai, with numerous skyscrapers illuminated with various colors of light. The foreground is a large, flat, tiled rooftop surface that recedes into the distance. The sky is a deep blue, suggesting twilight or early night.

EVOLVING WITH  
CUSTOMERS AND  
SOCIETIES IN A  
CHANGING WORLD

A nighttime photograph of a city skyline, likely Beijing, featuring several prominent skyscrapers illuminated with lights. The foreground is a large, flat, tiled plaza that recedes into the distance, creating a sense of depth. The sky is a deep blue, suggesting dusk or dawn.

Sandvik stands at the forefront of an exciting transition with urbanization at the center, aiming to develop innovative solutions together with societies. Unlocking the seemingly limitless potential of connectivity, predictive analytics, embedded sensors and big data is just one focus. Pioneering material research is another, where Sandvik has more than 150 years of experience.

TEXT: ÅSA BACKMAN

**AS FAR AS WE KNOW**, we've only got one world at our disposal – a world that is truly under pressure. Factors such as climate change and population growth, along with political and economic instability, call for new ways to handle the present and plan for the future. Sandvik stands at the forefront of this exciting transition, which comes with both challenges and opportunities.

**IT IS ESTIMATED THAT** today's world population of 7.4 billion will grow to approximately 10 billion by 2050. Providing these people with food and freshwater is one of the most urgent challenges we must meet. Utilizing existing arable land sustainably and innovatively is key.

"Applying excessive conventional fertilizers is pointless and harmful to the environment, as it will only pollute water and air," says Steven Sutanto, Global Product Manager, Fertilizers, at product area Sandvik Process Systems. "What plants need are fertilizers with a balanced nutrient content. Sandvik contributes with a solution to create specialty fertilizers through the addition of other nutrients, even micronutrients, into the main fertilizer."



Rotoform™ pastillation units from Sandvik at the Grupa Azoty Puławy's plant in Poland are used to create specialty fertilizers through the addition of other nutrients, even micronutrients, into the main fertilizer.

---

## Several Sandvik business areas contribute with tools, materials and solutions that help connect people, both virtually and physically.

**URBANIZATION IS A STRONG** macro trend and megacities are developing around the world. Sandvik offers a strong portfolio of products and solutions that help these cities grow efficiently and sustainably.

At the same time, our growing connectivity is providing a huge potential for a high-quality life in the countryside as well. Numerous jobs can be performed from a computer somewhere in a beautiful rural village, supported by sporadic physical meetings with colleagues. Fast and timely transport that enables these meetings is, however, a prerequisite. Several Sandvik business areas contribute with tools, materials and solutions that help connect people, both virtually and physically – everything from productive tunneling equipment to metal-cutting tools required for the production of electronic devices, such as mobile phones and computers.

**WHILE CITIES ARE GROWING** and an increasing number of people have the option to decide where in the world to live, many of the earth's underground resources remain in their often distant and unfriendly locations. But the inaccessible is becoming more accessible. With the use of new technology and intelligent solutions, many tasks can actually be controlled at a distance, enabling people to perform their jobs in a modern and comfortable control room rather than on site. And for jobs that must be performed on site, in a mine or on an oil platform for example, safety and the working environment are a constant focus for both Sandvik and its customers.

Moreover, Sandvik offers a strong aftermarket service, which is a draw for customers. "You can have the best unit in the world but if there's no service support and no reliable parts supply, then it doesn't matter how good the unit is, it's going to result in downtime," says Barry Upton, Managing Director at RUC Mining, one of Sandvik's customers in Western Australia.

With a wide portfolio of strong products and solutions and a deep concern for the world in which we live, Sandvik, working with its customers and society at large, is contributing to a better today and a brighter tomorrow. ■

# GEARING UP THE AUTOMOTIVE INDUSTRY WITH INNOVATIVE MANUFACTURING

The Proving Factory aims to fill the gaps in the UK's automotive supply chain, and with Sandvik's software InvoMilling™ 1.0, machining external gears and splines, they have managed to increase cost efficiency and reduce lead times.

**THE EUROPEAN** economy relies heavily on its automotive industry. According to the European Commission, the automotive sector accounts for approximately 12 million jobs.

**THE GROWTH OF** the industry, however, is happening elsewhere. It will require hard work, targeted initiatives and lots of innovative thinking to remain competitive compared with faster-growing economies.

**THE PROVING FACTORY**, jointly run by Tata Steel and engineering consultancy Productiv in the United Kingdom, is an initiative that is aiming in that direction. Through funds from both the private sector and the government, it aims to fill the gaps in the UK's automotive supply chain. The initiative is an important resource for small to medium-sized companies and university groups, helping them to develop innovative technology, scale up



When Tata Steel Speciality Steels saw Sandvik Coromant's demonstration of the innovative software InvoMilling™ 1.0 for the production of gear components, it immediately recognized the potential for its new business venture, the Proving Factory.

## EMPOWERING A SMOOTH URBAN TRANSITION

from prototype to large-volume manufacturing and bring their innovations to market.

**IN TERMS OF GLOBAL** competitiveness, cost-efficient gear production is an important factor. To that end, the Proving Factory has partnered with Sandvik Coromant for the software InvoMilling™ 1.0. Andy Woods, Business Development Manager, Tata Steel, explains that the Sandvik solution has had a profound impact. "It gives us the ability to cut straight and helical gears with close tolerances at low tooling costs," he says.

**INVOMILLING IS AN** innovative method for machining external gears and splines. Since its introduction in 2015, the method has drastically changed the landscape for the transmission industry. With its patented software, the same cutters can be used for different gear profiles, which reduces lead times and significantly cuts manufacturing costs. Changing the computer numerical control (CNC) program rather than the tooling means that complete components can be machined in a single setup on multi-task machines or 5-axis machining centers. ■

Today, more than 50 percent of the world population lives in urban centers, and that number is increasing rapidly. Building sustainable cities that meet this demographic change presents a lot of challenges, infrastructure being one.

**HIGHWAY 91** is one of the enormous freeways running through Southern California. When Environmental Remediation Services Inc. (ERSI) was contracted to help widen the Route 91 corridor in the city of Corona, a key part of the project was to demolish a sizable highway overpass. The challenge was to do it without ever completely shutting down the highway, meaning there was no room for unplanned downtime. ERSI selected the hydraulic hammer Rammer™ 4099 for the project. The power-to-weight ratio and reputable performance in combination with the operator-friendly environment were important parameters in the selection.

"We were working Rammer 4099 in high-elevation scenarios for a solid 22 hours," says on-site ERSI Superintendent Glenn Beam. "It performed extremely well."

**ERSI WORKED IN PHASES** and managed to simultaneously build back the structure and open new lanes during the demolition process. Thanks to the performance of the Rammer 4099 hammer, the project beat the anticipated completion date and could open up the freeway eleven hours ahead of schedule. ■



## SUSTAINABLE TUNNEL CONSTRUCTIONS IN CHALLENGING LANDSCAPES

Anyone who has traveled in Norway knows it can be challenging. Impressive mountains and beautiful fjords that cut deep into the landscape make both driving and train journeys very time-consuming. Flying is often the only option if you don't have lots of time. Until now, that is.

**WHEN NSB AS**, the Norwegian state-owned railroad company, started building a high-speed railway, creating a triangle from Oslo to southern Norway and then up to Bergen, navigating the scenic attractions required a great deal of innovative thinking as well as experienced partners.

**THE DUTCH** construction company Hollandia Structures BV was one such partner. The company was commissioned to provide the ceiling construction inside the Holmestrand station. The town itself is situated on top of a mountain, and the high-speed train station runs right through the mountain at sea level. To ensure safe construction, Hollandia looked for a corrosion-resistant material with high strength. The solution can be seen as a ceiling suspended from the rock in adjustable hangers made of duplex hollow bar.

"Duplex stainless steel is unbeatable if you want a corrosion-resistant material with excellent mechanical properties," says Christer Thorsson, Global Product Manager for Hollow Bar at Sandvik.

"Maintenance-free Sanmac™ 2205, with its long lifetime and low weight, was a perfect match for Hollandia."

**BECAUSE OF** the short lead time, Dyon Hermesen, Dutch Sales Area Manager, and Thorsson worked closely both with the customer and internally to manage the delivery of Sanmac™ 2205 hollow bar.

"We had 12 weeks from order to delivery," says Thorsson. "As it takes us five to six weeks to prepare the raw material, we only had around seven weeks to produce the hollow bar. There was just no room for mistakes, so we had to have the whole chain, from R&D to planning and production, with us."

**THE HOLMESTRAND** station will open this summer, and Thorsson hopes that its successful completion will lead to other similar projects in the future. "We've learned a lot," he says. "I also think that it is a great reference for Sandvik, as it continues to build our brand as the unrivaled expert of duplex stainless steel." ■





# BALANCED FERTILIZERS FOR A GROWING POPULATION

As the world population continues to grow, the need for good nutrition increases. Excessive use of fertilizers to promote faster growth and more crops will not do the job and will instead contribute to water and air pollution.

**BALANCED FERTILIZERS** are the answer to higher productivity, healthier crop growth and minimized environmental impact.

**THE MOST COMMONLY USED** fertilizers today are ammonium nitrate and urea, used to supply nitrogen. Depending on the plant and soil conditions, however, additional nutrients are needed – mainly phosphates, potassium and sulfur. When Grupa Azoty Puławy in Poland planned a new fertilizer plant, the company invested substantial time and money into research to find a versatile and efficient solution to produce new types of fertilizers and at the same time meet strict environmental demands.

“The choice fell on the Sandvik solution, which includes Rotoform™ pastillation units where Grupa Azoty Puławy could easily produce specialty fertilizers by adding ammonium sulfate to the urea melt,” says Steven Sutanto, Global Product Manager, Fertilizers, at Sandvik Process Systems. “With small modifications, it could also add micro-nutrients such as zinc and iron.”

**PUŁAWY EVALUATED** several other systems with excellent production capacity, but no other system could

match pastillation by Rotoform™ when it came to versatility, and uniform size and shape.

In addition, says Sutanto, “the customer was impressed by the modularity of our system. With this solution, they could easily scale up when demand increased. They could also adjust the content for specific crop needs. In addition, product shape and size were always uniform, which is important for even spreading in the fields.”

**THE SYSTEM OPENED UP** opportunities for Puławy to venture into new markets with an extended product chain. The only challenge with the new system is getting the market to get used to the pastille shape. “Farmers are used to ball-shaped granules or prills,” says Sutanto. “The new system produces half-ball-shaped pastilles, which has no effect on either spreading width, crushing strength or caking properties. But I’m sure that the new multi-nutrient fertilizers will quickly convince even the most conservative farmer. I’m proud of being able to contribute to building a better tomorrow through our innovations.” ■



## GOLDEN OPPORTUNITIES FOR SAFE MINING

In 2014, when Australian gold producer Saracen initiated a transformation from open-pit to underground mining at the Karari mine, RUC Mining got the job to develop an exploration decline – and partnered up with Sandvik.

**A HIGHLY EXPERIENCED** team of mining professionals, a strong safety focus and a close partnership with Sandvik were three important factors in achieving this success. And after just eleven months, RUC Mining had far exceeded Saracen's expectations.

"We can do a boring cycle in around an hour and three quarters, where we actually scheduled for two and a half hours for a decline round," says Adrian Short, Operations Manager at RUC Mining. "That really improves our cycle times; hence we get more meters."

**LIKE SANDVIK**, RUC Mining has a strong focus on safety, which was the first priority when selecting equipment and a partner for the Carosue Dam project. RUC Mining sought a versatile jumbo drill combined with a powerful loader that fulfilled its strict safety parameters. The company ultimately chose two products from Sandvik, DD421 twin-boom jumbo and LH517 loader.

**THE EQUIPMENT IS** used for several functions, including face drilling, handling mesh, installing intensive ground support and drilling long anchors. The jumbo's feed rail is also used to move a dewatering pump at the face, which eliminates the need for people to lift in a potentially hazardous area.

"Not only did DD421 suit us as an underground miner, it also helped satisfy our first priority, which is the safety of our employees," Short says. "DD421 improves safety for us at the face and is also very fitter friendly. Everything is serviced from the ground and nobody has to climb on the rig."

**RUC MINING RELIES** on Sandvik for more than just equipment, tools, parts and technical support, however. "We are partners in many senses of the word, in terms of what a partnership involves – working together to improve performance," says Barry Upton, Managing Director at RUC Mining. "Our partnership is healthy and strong, and that's assisting us in delivering superior performance." ■

# HOW TO CAPTURE THE POWER OF THE WIND

The search for smart ways to harness the power of the wind and pave the way for sustainable energy has triggered a wave of innovative solutions and daring designs in different sizes and materials.

TEXT: JOHAN RAPP

**WHILE SOME** projects are well on their way, others are on hold for lack of funds. But Sandvik is keeping a close eye on developments within the wind power industry to help emerging energy technologies succeed through efficient manufacturing and optimal material quality and cutting. Here are a few inspiring ideas.

## HIGH IN THE SKY

An unmanned glider can generate a substantial amount of power as it climbs and extends a cable connected to a ground station, where a generator converts the movement to electricity. When the glider dives, the cable is rolled up and a new cycle begins.

Ampyx Power is developing such a glider power plane, and the company says it has a much higher capacity than conventional turbines, due to the continuous strong winds that blow at greater heights. It also promises manufacturing costs that are a fraction of the cost of conventional power stations.

## A SEA DRAGON

Aerogenerator X, as envisioned by UK-based Wind Power Ltd., measures 274 meters from tip to tip and looks like a two-headed sea monster extending two long necks in a V-shape high above the water's surface. At the top are airfoils that operate the vertical turbine, mounted on a floating platform far out at sea.

## VIBRATING WALLS

A wall of fluttering panels can capture the wind and transform it into electricity. Researchers at Cornell University in the United States say their Vibro-Wind power station project, made of oscillating foam pads, works at much lower wind speeds than conventional propeller-based solutions. They do not harm the environment and can be put on top of any structure, such as office buildings.



Aerogenerator X measures some 274 meters from tip to tip.

### WOOD FOR BEAUTY

Enessere, in northeastern Italy, specializes in making a small wind turbine that is both aesthetically pleasing and effective in generating electricity. The Hercules Wind Turbine is just nine meters tall and consists of a stainless steel structure that supports spiraling wooden-layered blades of American cedar. It emits a maximum of 38 decibels at gusts of 12 meters per second.

“There is a lot of resistance toward wind turbines,” says Oliver Glemser, one of Enessere’s three full-time staff. “People complain of their ugliness and disturbing presence. This is our answer.”

### TOWERS WITHOUT BLADES

The Spanish company Vortex Bladeless envisions fields with farms of turbine tower-looking pillars without blades. When it’s windy, power is generated from the aerodynamic effect of spinning vortices (vorticity), which creates oscillating motion in the pillars. The company says these power stations would be noiseless, cheap and easy to maintain. The company has launched a crowd-funding campaign to get the project off, or rather on, the ground.

### How does Sandvik contribute?

As a world-leading provider of metal-cutting solutions, Sandvik helps wind turbine manufacturers improve component quality and productivity in the machining of bearing houses, gearbox housing, gearbox shafts, rotor blades and more.

Precision, performance, durability and how efficiently these components can be manufactured are all critical in providing maximum output at low cost.



Enessere’s beautiful Hercules Wind Turbine is just nine meters tall and consists of a stainless steel structure with wooden blades made of American cedar.

# LESS IS MORE IN THE CIRCULAR ECONOMY

**WITH RAW MATERIALS** and natural resources becoming ever more scarce, the need to improve sustainability in a commercially viable way is growing more acute. The challenge is to ensure the smooth running of a complex supply chain while simultaneously keeping waste to a minimum, lowering the impact on the environment and staying cost-effective.

**WE MET GARY TULLY**, Raw Materials Controller at Sandvik, to discuss how Sandvik stands on this issue. Tully began his career as a technical engineering apprentice in the automotive industry before moving into a supply chain function. He eventually headed a large team, ordering and procuring parts for the production line. This experience has proved an ideal preparation for his current role at Sandvik.

“When I joined Sandvik ten years ago, a number of recycling initiatives were in place at varying stages of implementation across the organization, with multiple goals and objectives,” he says. “We have now harnessed those efforts and consolidated them to become an integral part of our process

**Gary Tully**

**Position:**  
Raw Materials Controller  
**With Sandvik since:** 2006

design, planning and company culture. These materials are finite, so we need to recycle our products optimally and strive for zero material losses in the production process.”

**TULLY, WHO HAS** a particular focus on the environmental side of the operation, is a member of the Raw Materials Board, which was set up three years ago with the primary aim of increasing transparency, fully utilizing synergies, controlling stock levels and optimizing recycling flows within the Group.

“Everything we do is ultimately driven by the goal of adding value for the customer,” says Tully. “Sandvik manufactures products from finite raw materials. We have a social responsibility to sustain those resources and minimize our environmental impact. As an industry leader we have to play our part in optimizing our circular economy and protecting the world’s resources.” ■

Sandvik’s main recycling material flow for its cemented carbide tools and their constituent raw materials has been developed through the repurchasing of used tools via customer buyback programs and then recycling those back into raw materials for new tools. The environmental impact is lower, the efficiency of the supply chain is greater, and the circle in this economy is completed.



# REPORT

CFO comment • Key figures from the first quarter 2016 • Meet Sandvik's new CFO  
• Short news • Shareholder voices

17,19	-0,06	-0,14%
42,14	+0,56	1,91%
27,07	+0,17	3,52%
21,18	+0,26	0,89%
27,33	-1,14	-4,08%
311,58	+13,53	3,32%
96,51	+0,82	0,54%
25,32	+0,41	1,62%
29,81	+0,28	0,94%

# POSITIVE BOOK-TO-BILL IN TOUGH MARKET

## HOW WOULD YOU DESCRIBE SANDVIKS' FIRST QUARTER 2016?

The market environment remained challenging in the first quarter, and order intake and revenues declined compared with last year. North America and Asia were the weakest of the major regions, while Europe outperformed with positive order development, supported by large orders in Sandvik Materials Technology. Aerospace remained a growth segment. Automotive was overall stable, while most other major customer segments trended down, compared with last year. We however reported a positive book-to-bill in four out of five business areas.

## CAN YOU SUMMARIZE THE EFFECTS OF ONGOING SAVINGS INITIATIVES?

The announced efficiency programs are progressing according to plan, and we are on track to

deliver on the targeted 2.1 billion SEK in savings as run-rate by the end of 2017. So far we have achieved 1.3 billion SEK in savings, which had a positive impact on the results in the quarter.

## WHY DID YOU DECIDE TO MERGE OPERATIONS IN SANDVIK MINING AND SANDVIK CONSTRUCTION?

Sandvik Mining and Sandvik Construction largely share manufacturing resources, their products are based on common technologies, and the aftermarket offering of both businesses is similar. By combining the business areas into one and moving operational decision-making into the product areas we achieve an even clearer focus and faster response to customers.



Tomas Eliasson, CFO



## FIRST QUARTER 2016\*

## REVENUES BY BUSINESS AREA

MSEK	Q1 2016	Q1 2015	Change %	Change % <sup>1)</sup>
Sandvik Machining Solutions	7,803	8,438	-8	-5
Sandvik Mining	4,952	5,489	-10	-1
Sandvik Materials Technology	3,231	3,712	-13	-12
Sandvik Construction	1,945	2,144	-9	-5
Sandvik Venture	1,763	2,172	-19	-18
Group Activities	6	5	-	-
Continuing operations	19,700	21,960	-10	-7

1) Change compared with preceding year at fixed exchange rates for comparable units.

## OPERATING PROFIT BY BUSINESS AREA

MSEK	Q1 2016	Q1 2015	Change %
Sandvik Machining Solutions	1,587	1,129	+41
Sandvik Mining	685	215	+219
Sandvik Materials Technology	216	100	+116
Sandvik Construction	83	-95	N/M
Sandvik Venture	95	192	-50
Group Activities	-253	-342	-
Continuing operations <sup>2)</sup>	2,413	1,199	+101

Operating profit adjusted for nonrecurring charges of 1.8 billion SEK for the first quarter 2015.

2) Internal transactions had negligible effect on business area profits.

## OPERATING MARGIN BY BUSINESS AREA

% OF INVOICING	Q1 2016	Q1 2015
Sandvik Machining Solutions	20.3	13.4
Sandvik Mining	13.8	3.9
Sandvik Materials Technology	6.7	2.7
Sandvik Construction	4.3	-4.4
Sandvik Venture	5.4	8.8
Continuing operations	12.2	5.5

\* Comments and numbers in the report relate to continuing operations, unless otherwise stated.

## REVENUES Business area share of Group's total revenues

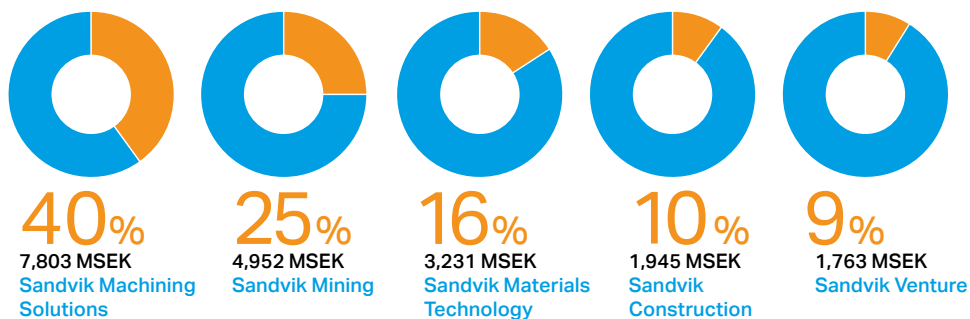

## REVENUES DEVELOPMENT by market area

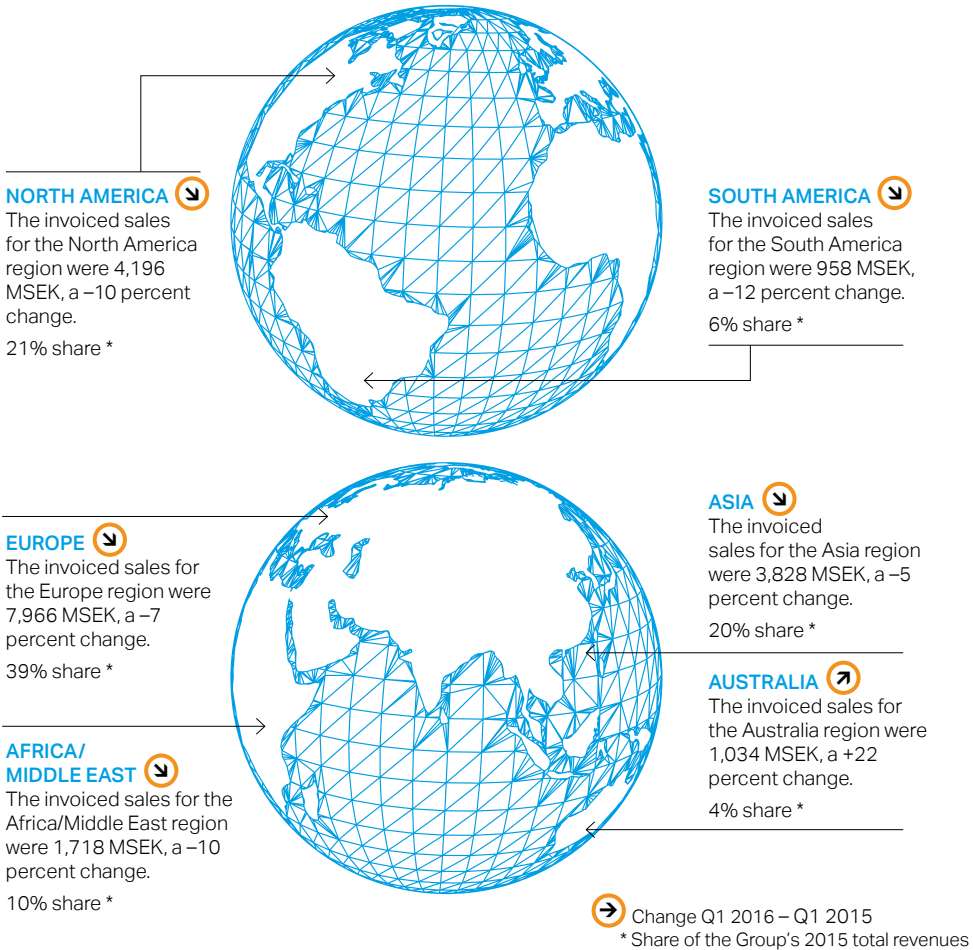

## REVENUES by segment \*

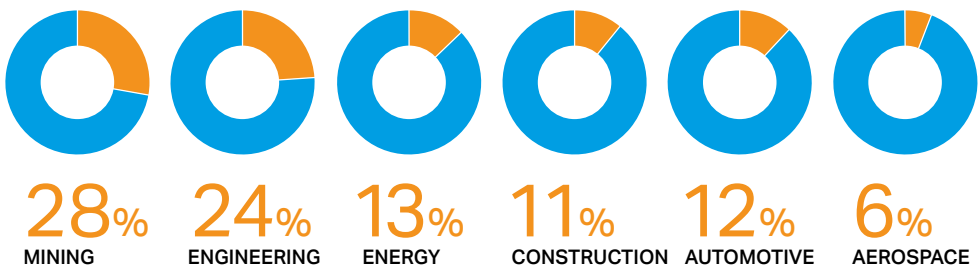

\* Share of the Group's 2015 total revenues; consumer goods, chemicals and miscellaneous total 6%.

# TOMAS ELIASSON, NEW CFO OF SANDVIK

As of April 1, Tomas Eliasson is Sandvik's new Chief Financial Officer as well as Head of Group Finance and IT.

## WHAT SORT OF EXPERIENCE ARE YOU BRINGING TO SANDVIK?

I bring a good deal of valuable experience from several interesting companies. I have primarily worked at global industrial companies. The central issues at global companies are similar, such as how to better integrate with the customer and how to get organized.

I think this is a really exciting time at Sandvik in terms of the direction the company is taking, what the shareholders want the company to achieve and how the management wants to drive the company forward.

## WHAT'S YOUR OPINION REGARDING SANDVIK'S SITUATION RIGHT NOW?

I feel there is an abundance of opportunities. Needless to say, it's a difficult period, but it's in difficult times that we are compelled to take actions that can create development – for example, by trimming

the organization and focusing on areas where we can build future growth. The markets will turn eventually and we'll emerge in better shape. The ups and downs of business cycles are quite normal, and although navigating through periods of change can prove difficult, it is important to identify the possibilities and how we can move forward.

## YOUR GREATEST CHALLENGES AHEAD?

The future change programs, when there is a lot happening at the same time and when new structures are being put in place and new management approaches adopted. It will be crucial to maintain our tempo, keep our focus and never give up. Everyone must be on the same page with the same focus moving forward.

## WHAT ARE YOUR EXPECTATIONS?

That my job will be very exciting. There's a lot to be dealt with, but I see only opportu-

nities moving forward. I look forward to getting to know the areas that are new to me and to good cooperation with all colleagues in the areas of finance and IT – and of course other co-workers too. ■



### Tomas Eliasson

**Career:** Before joining Sandvik, he occupied similar positions at Electrolux, Assa Abloy and Seco Tools. He began his career at ABB in 1987.

**Family:** Wife, three children, a cat.

**Interests:** Skiing, sailing, traveling and reading – right now Stephen Hawking.

## HIGH ENGAGEMENT AT THE ANNUAL MEETING



**A CLEAR ORGANIZATIONAL** structure and focus on the areas where Sandvik is or can become the market leader: those were some of the messages conveyed at Sandvik's Annual General Meeting, which attracted some 1,000 shareholders.

Björn Rosengren, President and CEO, underlined in his

speech that Sandvik has to be agile to understand its customer needs and adjust to different and challenging market conditions.

During the pre-program, the honored team of Minna Pirkkanen, Hannu Helen and Jouni Teppo from Turku, Finland, received the prestigious Wilhelm Haglund medal

"The product developer of the year". The team was awarded for the development of a new modular family of trucks for underground mining.



## NEW HEAD OF HUMAN RESOURCES



Sandvik has appointed Johan Kerstell Executive Vice President, Head of Human Resources, and member of Sandvik's Group Executive Management, starting in June 2016. Kerstell has been with Sandvik since 2004.

## THREE BUSINESS AREAS FOR EVEN BETTER CUSTOMER FOCUS

**EFFECTIVE FROM JULY 1, 2016**, Sandvik will merge its operations Sandvik Mining and Sandvik Construction into a single business area – Sandvik Mining and Rock Technology. Sandvik Venture will be dissolved and parts of its operations reorganized into Sandvik Machining Solutions and Sandvik Mining and Rock Technology. Sandvik Process Systems and Sandvik Hyperion will be reported as other operations.

## TWO SHAREHOLDER VOICES

We asked two shareholders about why they decided to invest in Sandvik, as well as their expectations moving forward.

**ERIKA BACKMAN** has been a Sandvik shareholder since she was 11 years old. "My parents bought me shares in 1998 because they wanted to give me a long-term savings," she explains.

### HOW DO YOU PERCEIVE SANDVIK AS A COMPANY?

"Sandvik has historically been a world-leading company with a good heart, combined with cutting-edge research and development that has been driving the industry forward. The past years have been a bit turbulent, and it's too early to see in what direction the new CEO and management team are heading. However, I have a good gut feeling."

### WHAT ARE YOUR EXPECTATIONS?

"For me as an organizational psychologist, it's obvious that the stock price reflects the leadership in the company – making the right decisions, setting clear goals and inspiring all employees to direct their combined power toward that goal. I hope the new management team feels the same. The stock development has been weak for a number of years, but I feel confident that it's still a good investment. I have no plans to sell my shares." ■

#### Erika Backman

**Occupation:** Organizational psychologist

**Lives in:** Copenhagen, Denmark

**Shares since:** 1998



**IN THE MID 1960s**, Curt Bergström took over the responsibility of the family business, three Intersport stores. Even though he has lived all his life in Sandviken, he never worked at Sandvik. His grandfather did, however, and Curt remembers visiting him at the head office where he worked as a night guard.

### WHEN DID YOU PURCHASE YOUR FIRST SANDVIK SHARES?

My parents always told me that Sandvik shares were a good insurance, so I bought my first shares as soon as I could afford it, about 30 years ago.

I've lived my life close to Sandvik and know a lot of people at all levels.

It seemed like a wise long-term investment then, and I've developed my portfolio over the years.

### WHAT ARE YOUR EXPECTATIONS?

I think that Sandvik is doing a lot of right things. The strong R&D focus is one example. I also think that the different business areas complement each other nicely. I expect a strong development up to around SEK 130 per share in the near future. ■

#### Curt Bergström

**Occupation:** Retired

**Lives in:** Sandviken, Sweden

**Shares since:** 1980s



# 20 YEARS OF MEET SANDVIK

In the spring of 1996, the first issue of *Meet Sandvik* was launched. Since then the magazine has gone through many changes – reflecting new times and new ways of doing things, as Per-Henrik Bergek, Editor-in-Chief from 1996 to 2010, recalls. It has always offered a mix of hard facts, interviews and soft features with a few recurring themes, such as products and solutions, people, technological innovations, safety and customer focus.



## NO. 1, 1996

The first covers featured a product set against a white background. “We often had a blur at the edges of the image, with a good focus at the center,” says Per-Henrik Bergek. First years: quarterly report was included.



## PRODUCT FOCUS

In the early days, Bergek recalls, Sandvik was extremely product-oriented. “You almost never talked about the people behind the products,” he says. But that changed.



## PEOPLE, PRODUCTS AND ENVIRONMENTS

In 1999, the cover was revamped. Instead of a product focus, it now featured a mix of images: Products remained, but people and different environments were added.



## PEOPLE IN FOCUS

In 2000, the cover was changed again, to feature Sandvik’s employees.

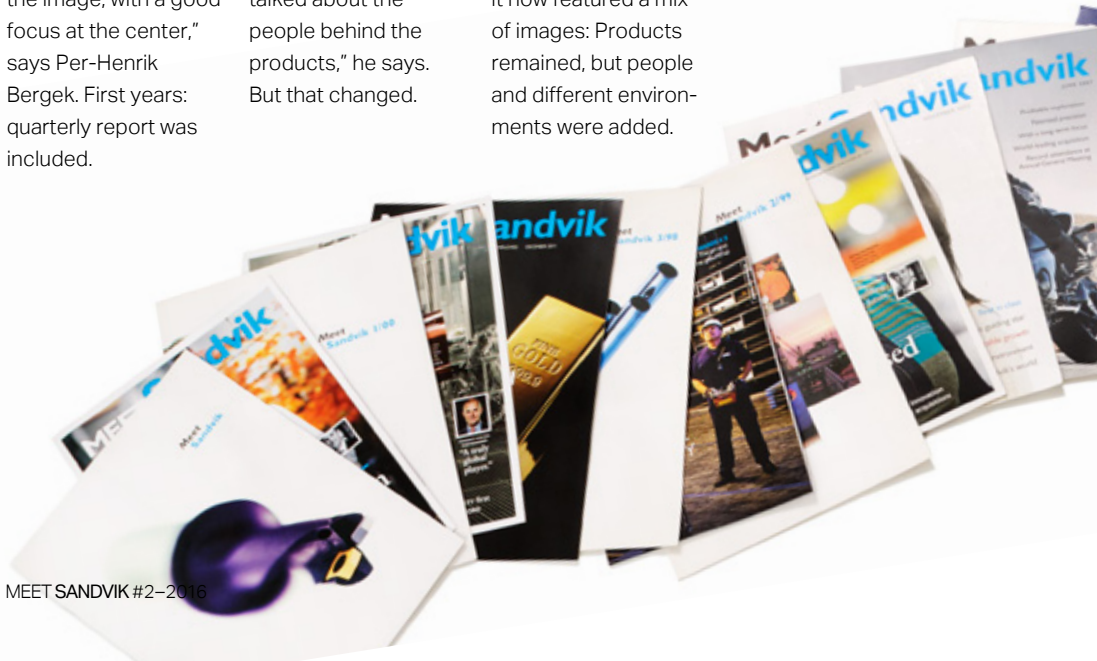



**LET US KNOW WHAT YOU THINK ABOUT MEET SANDVIK,** and how you would like to see it develop. Please fill in the web survey at [home.sandvik/meet-sandvik-survey](http://home.sandvik/meet-sandvik-survey).



### THE GLOBE

In **2005** the focus for the magazine became both wider and more global, illustrated by a globe filled with people, products and environments. The President and CEO started to comment on the recent quarter.



### MAGAZINE DESIGN

In **2006** the white background was replaced with a colorful image that filled the whole page. "Meet Sandvik started to look even more like a magazine," Bergek says.



### ONE SANDVIK

The new "One Sandvik" strategy was reflected in the magazine in **2012**. Again, an employee was highlighted on the front and back pages.



### NEW FORMAT

In **2015**, the magazine changed to a smaller format and was aligned with Sandvik's new brand platform. The change included an even more obvious customer and product focus, as well as a clearer connection to digital channels and topics.



Meet Sandvik is printed in English and Swedish and is distributed to all shareholders, Sandvik offices and partners all over the world. It is also available in PDF format at the Group's intranet and external website, [home.sandvik](http://home.sandvik).



**THE OBJECT** | Halftime for replacing the bolts of the Vasa ship

---

**Sweden's historic Vasa ship** is under threat from iron leakage from its steel bolts. In 2011, the Vasa Museum joined forces with Sandvik to preserve the nearly 400-year-old wooden warship for future generations. All 5,500 bolts are scheduled to be replaced by the end of 2017, and with 2,800 bolts exchanged so far, it is clear that Sandvik's specially designed bolts have made the Vasa more stable and in fact lighter. The materials used are Sandvik SAF 2707™ HD and Sandvik SAF 2507™, a combination of advanced duplex stainless steel grades with excellent corrosion resistance and mechanical strength that can support the weight of the Vasa's 900-ton hull.